

| | | | | | |
|--|--|--|--|--|--|
| | | | | | |
| | | | | | |

4x2,4

2

1

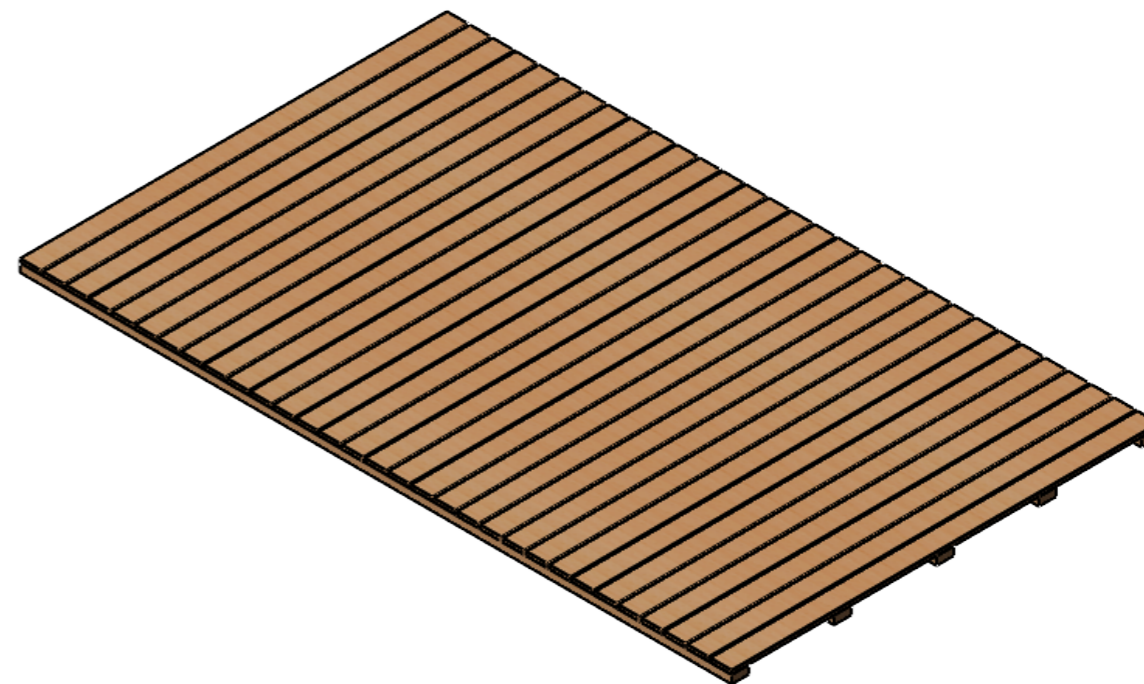
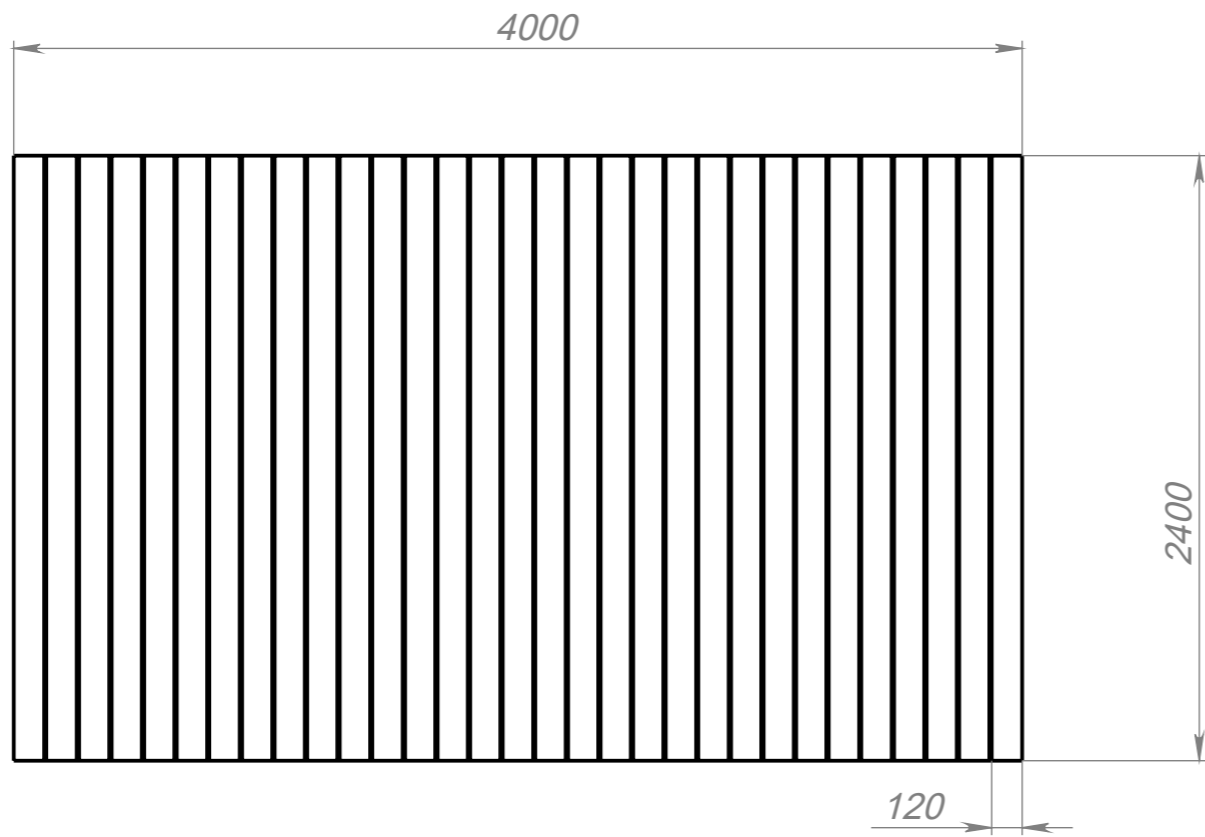
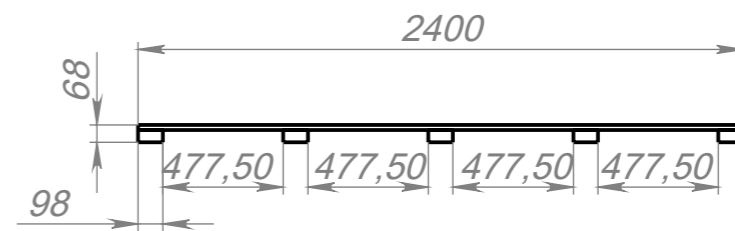
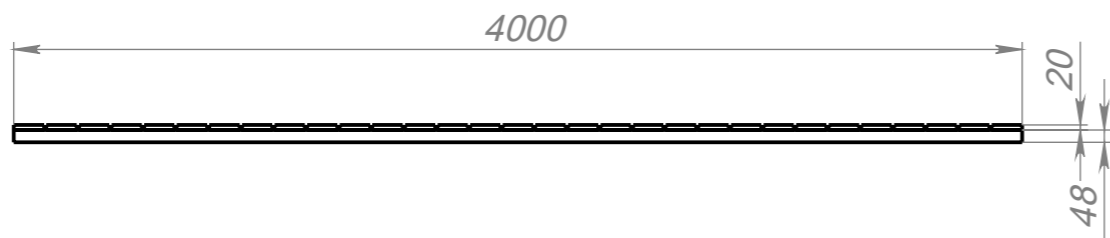

A



2

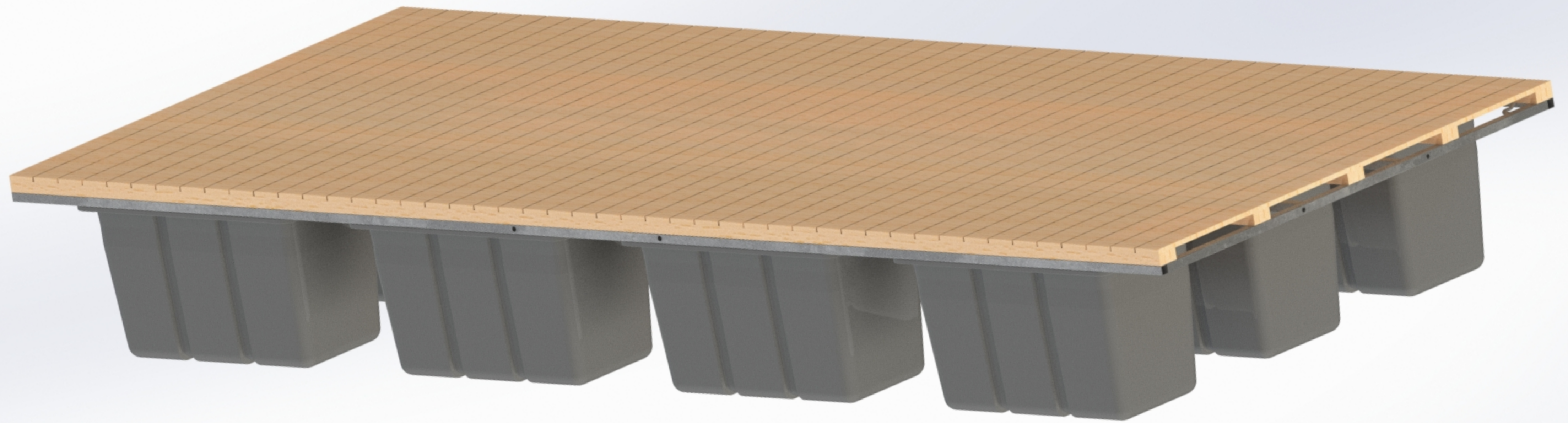

2

1

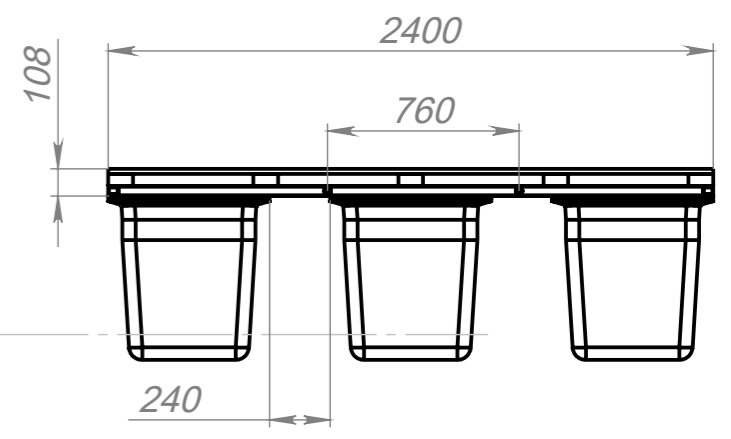
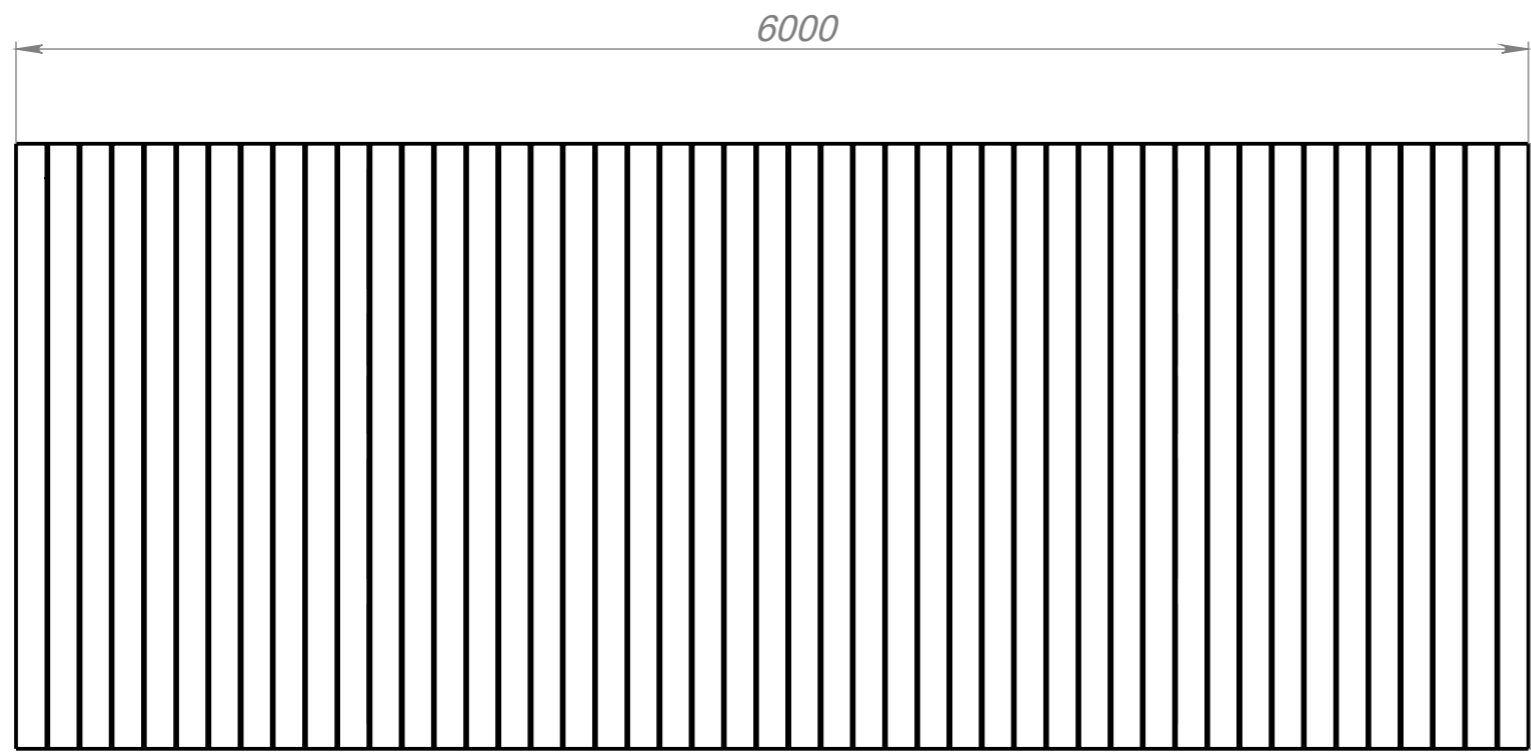
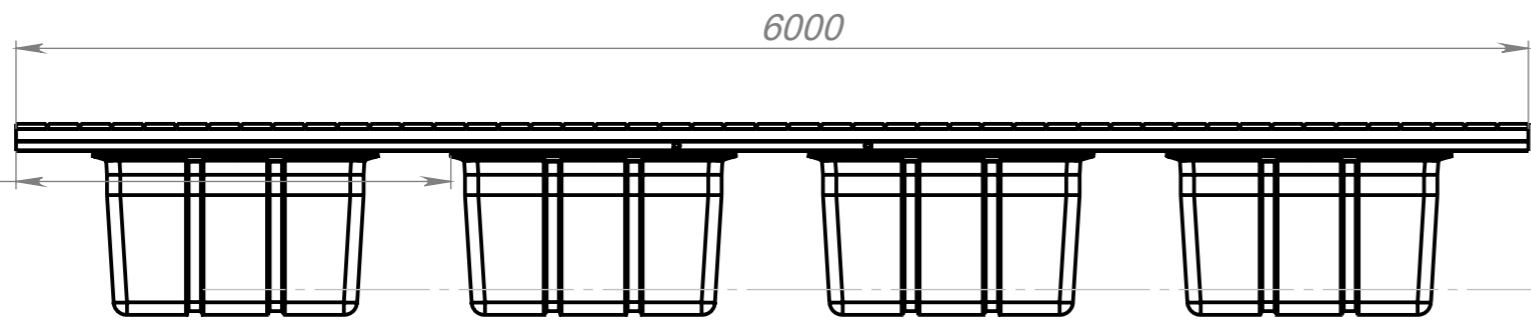

freeboard

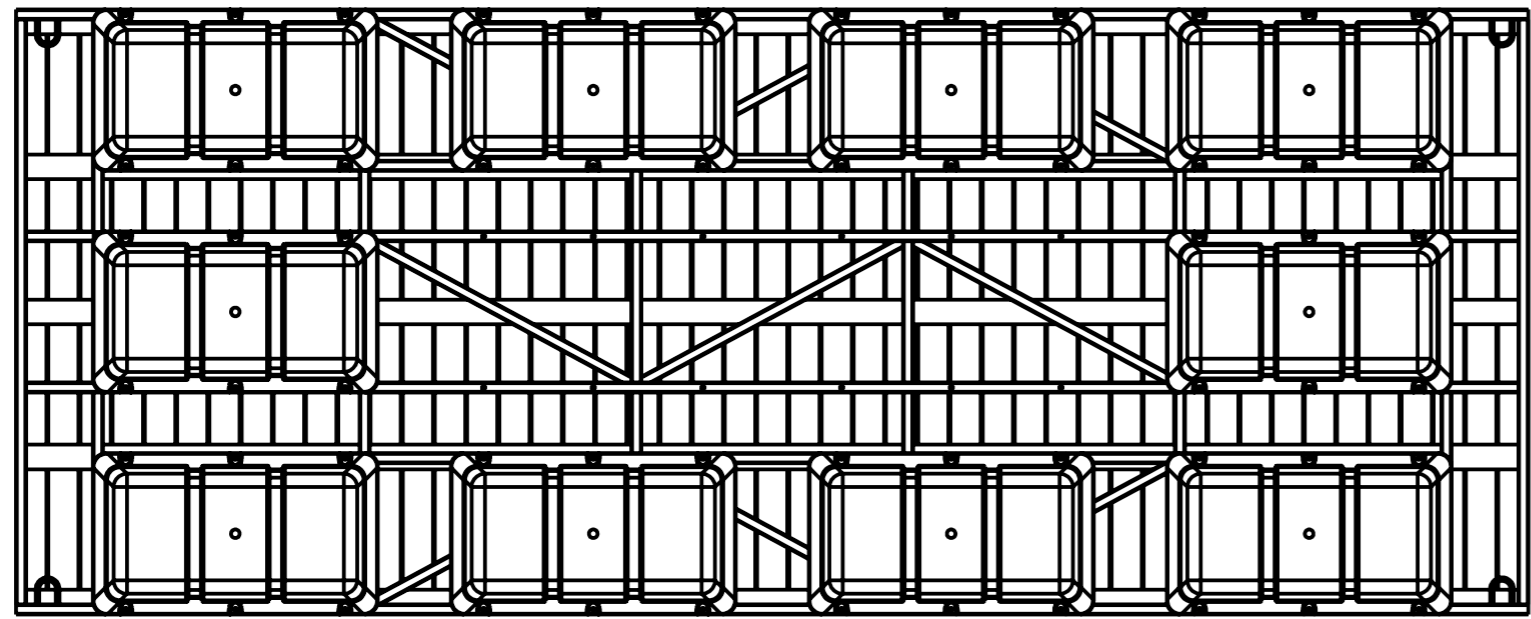

Weight of metal and decking - 510 kg
 Weight of metal - 249 kg
 Decking square- 14,4 m2.

| | | | | |
|--|--|--|--|--|
| | | | | |
| | | | | |

6x2,4

1

2

1

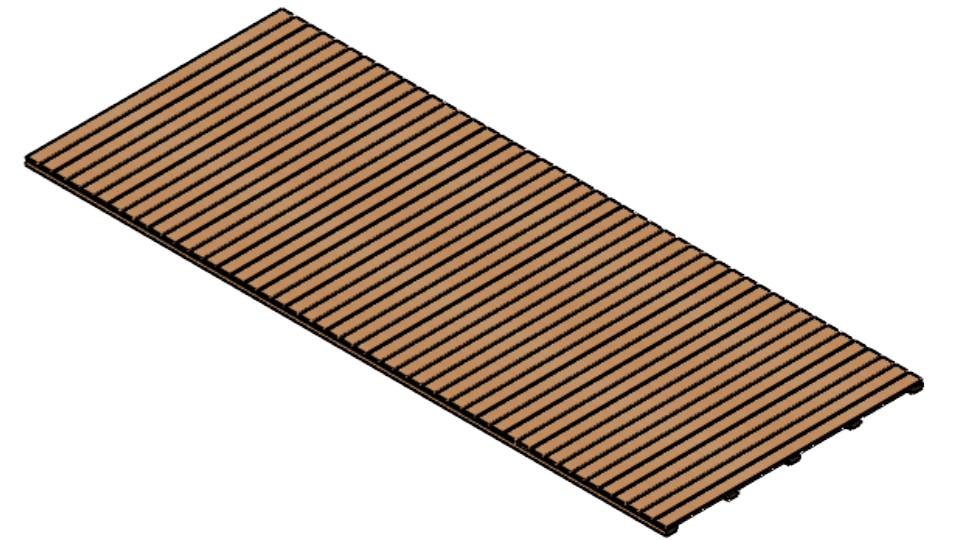
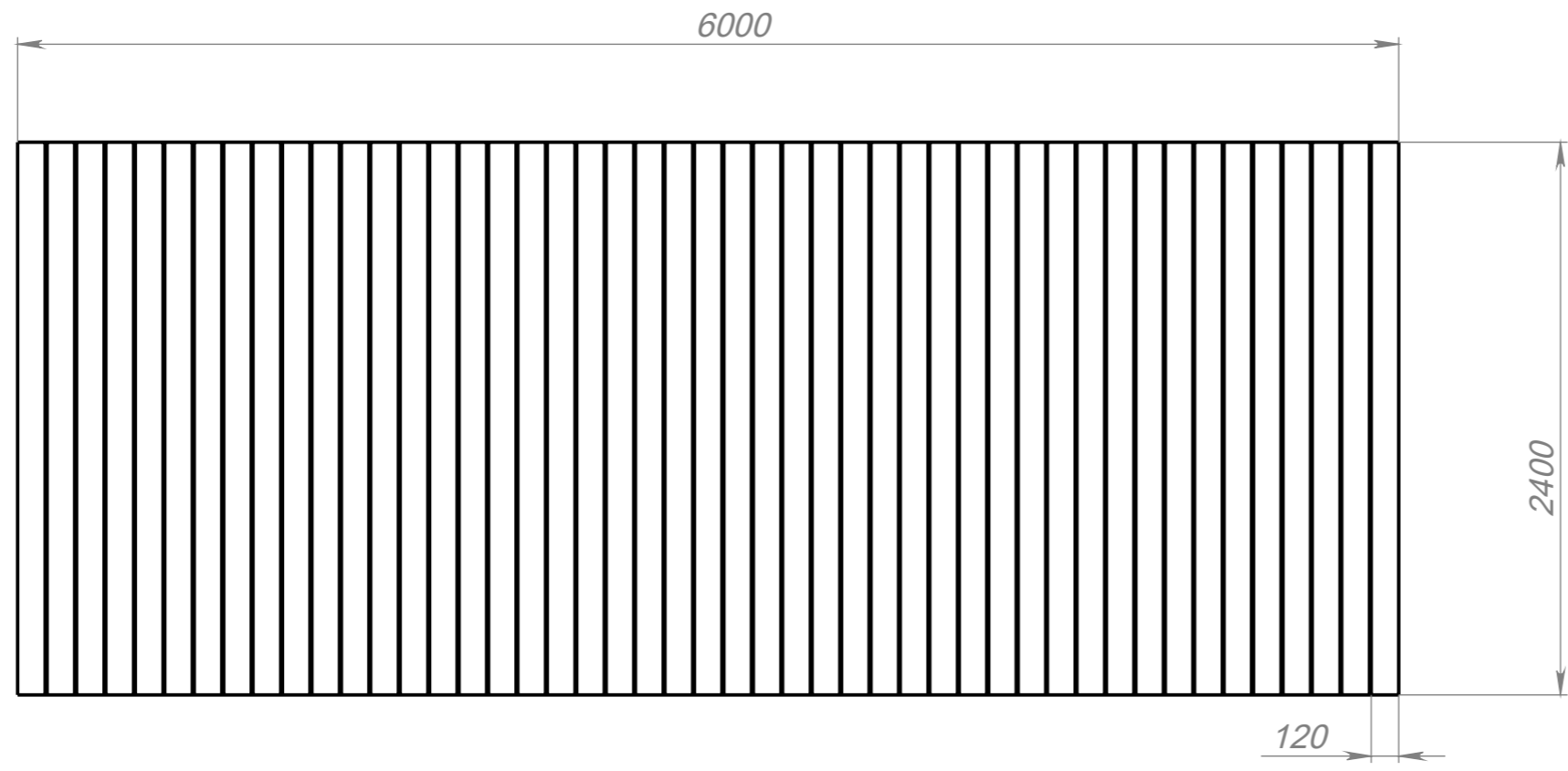
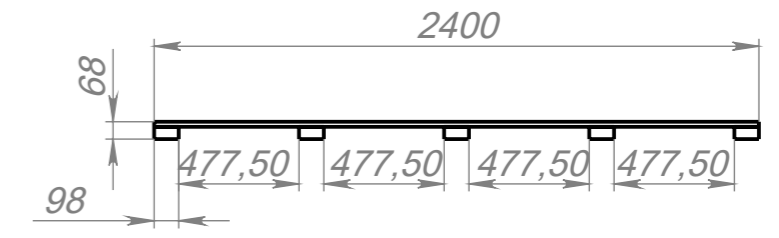
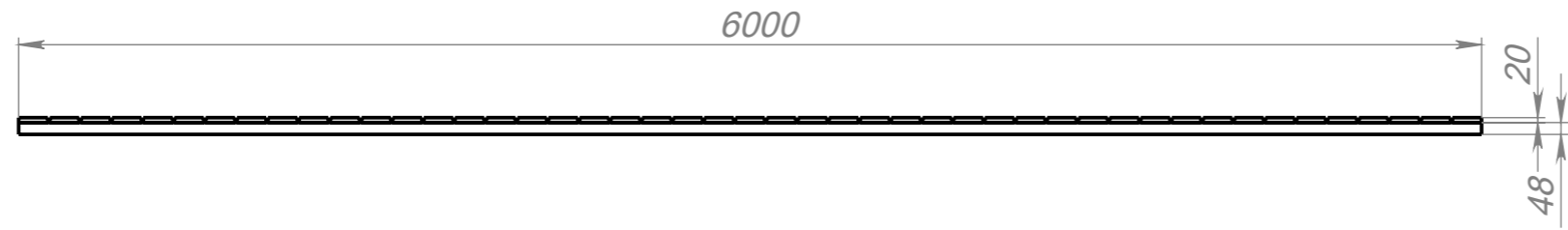

2

1

2

1

A

6x2,4

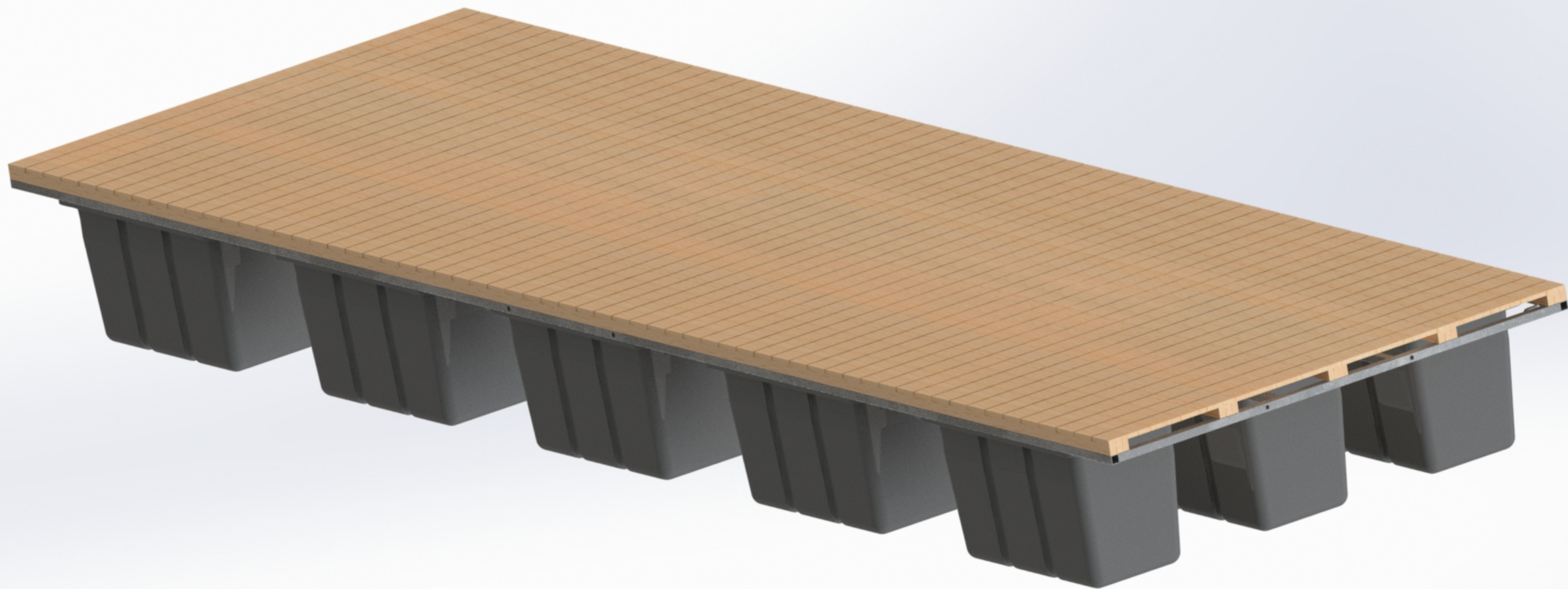

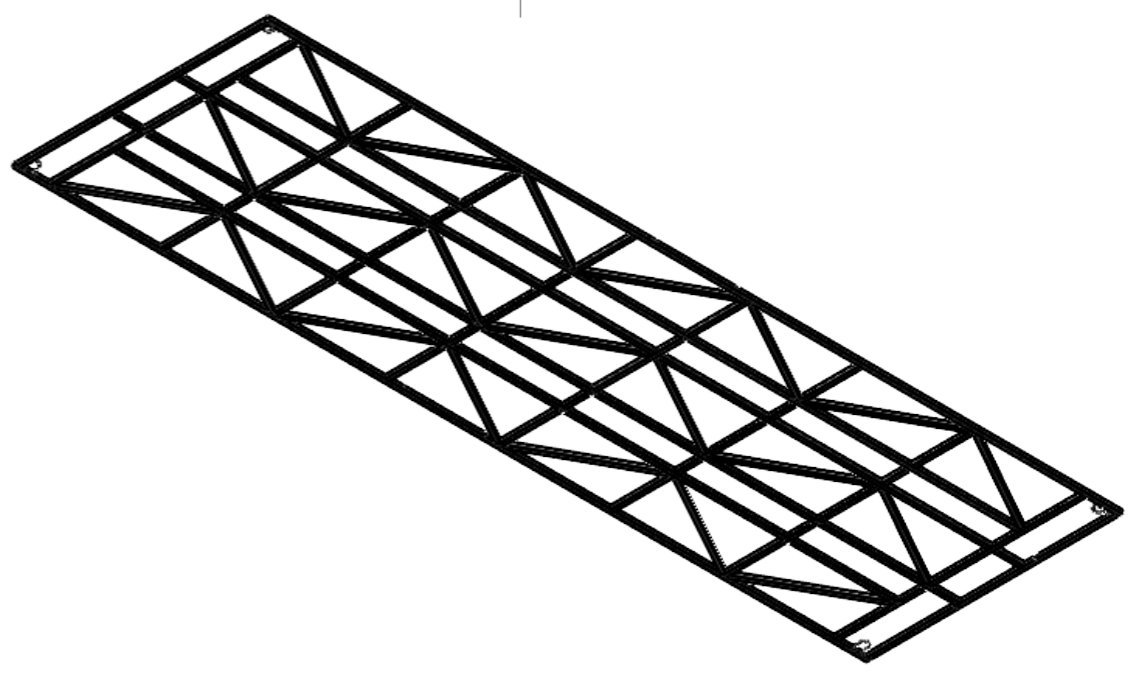
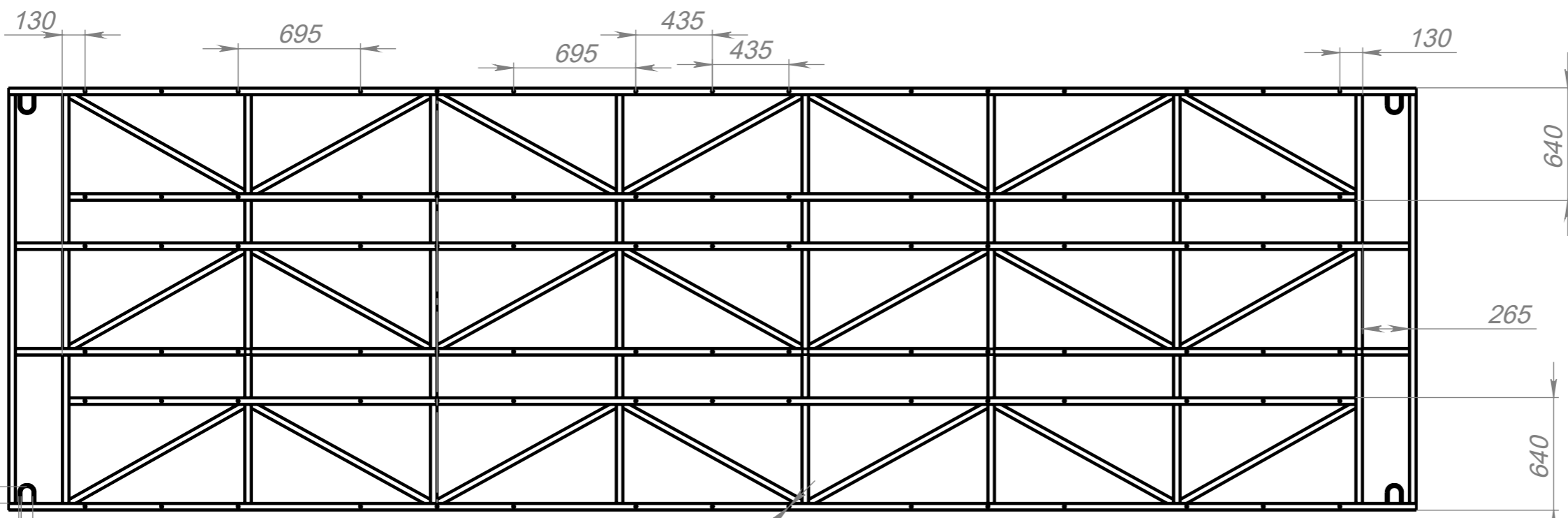
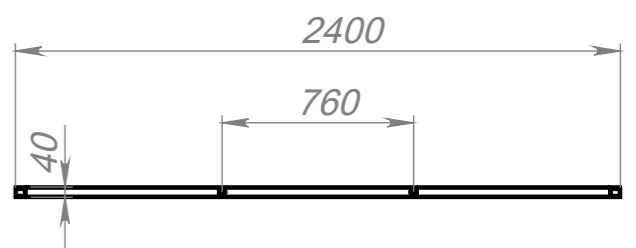
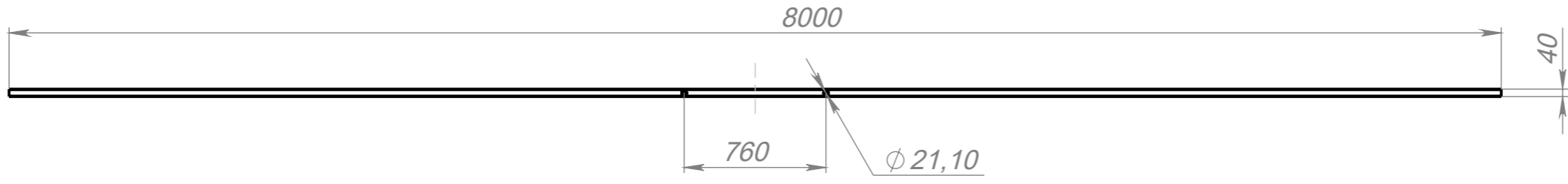

| | | | | | | | |
|--|--|--|--|--|--|--|--|
| | | | | | | | |
| | | | | | | | |

8x2,4

2

1

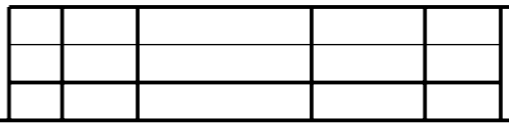
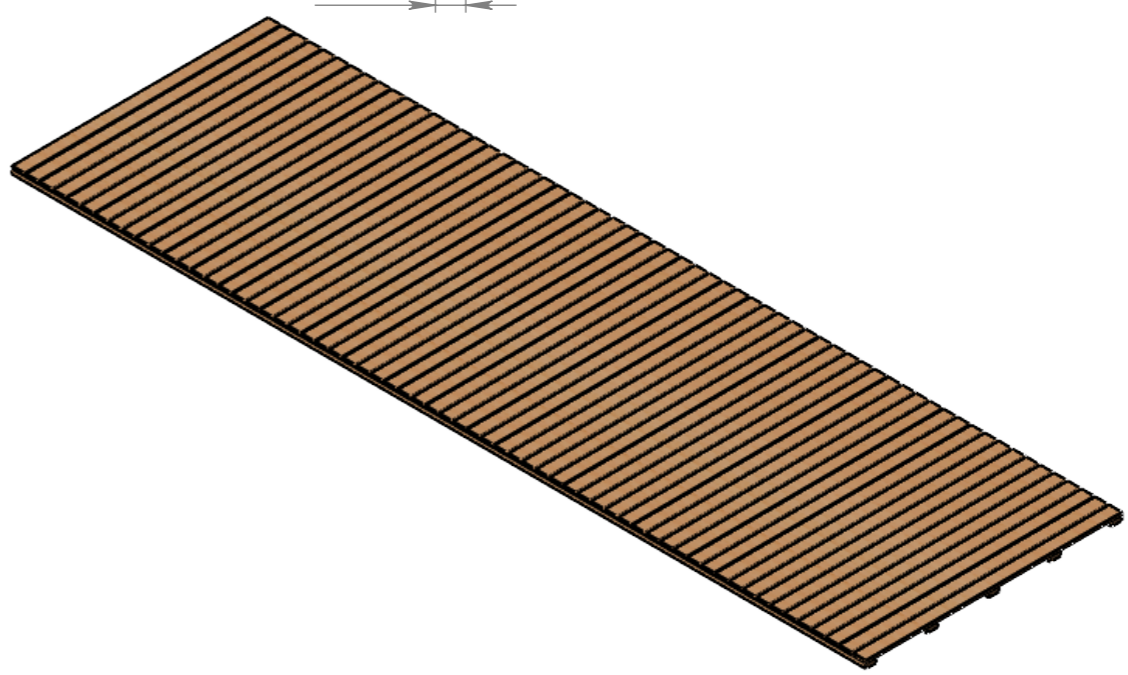
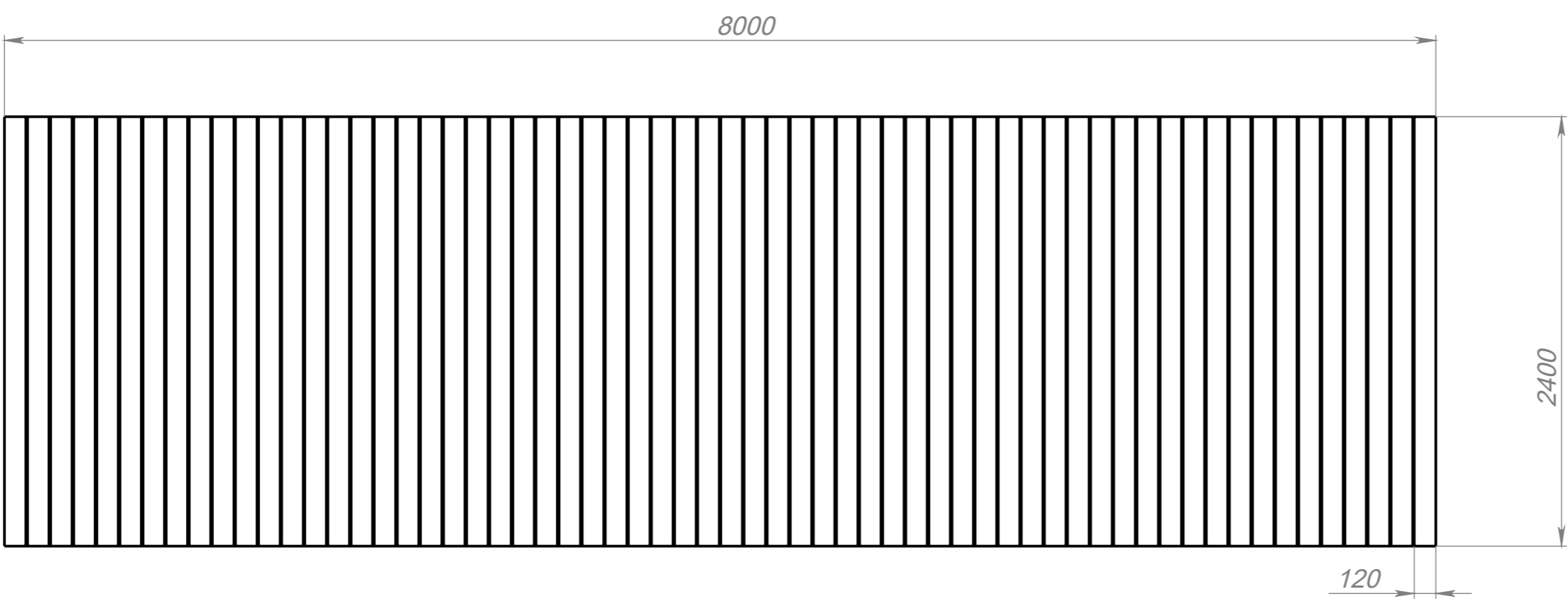
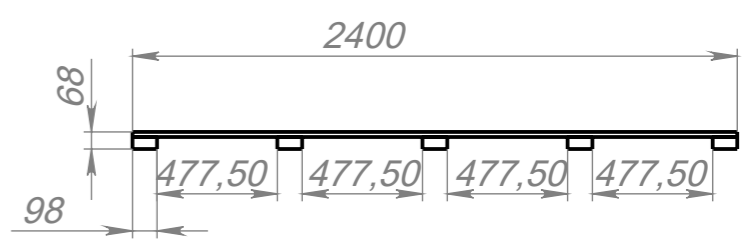
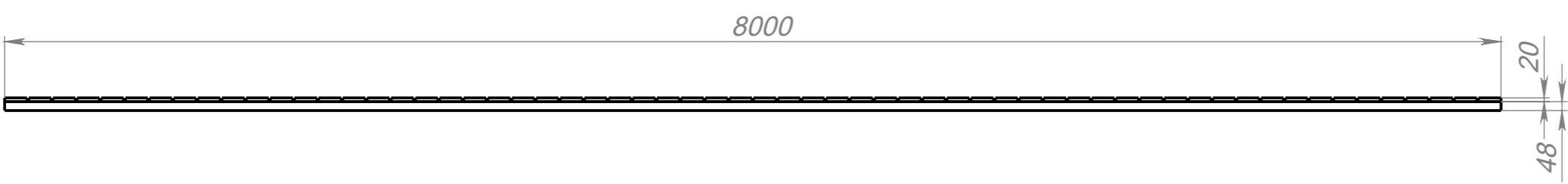

8x2,4

2